

Article number: 2030120M20150A1U

Description: E+G levelling foot
GN 30-120-M20-150-A1-U

Note: U Without nut, Hexagon socket at the top, Wrench flat at the bottom

Measures

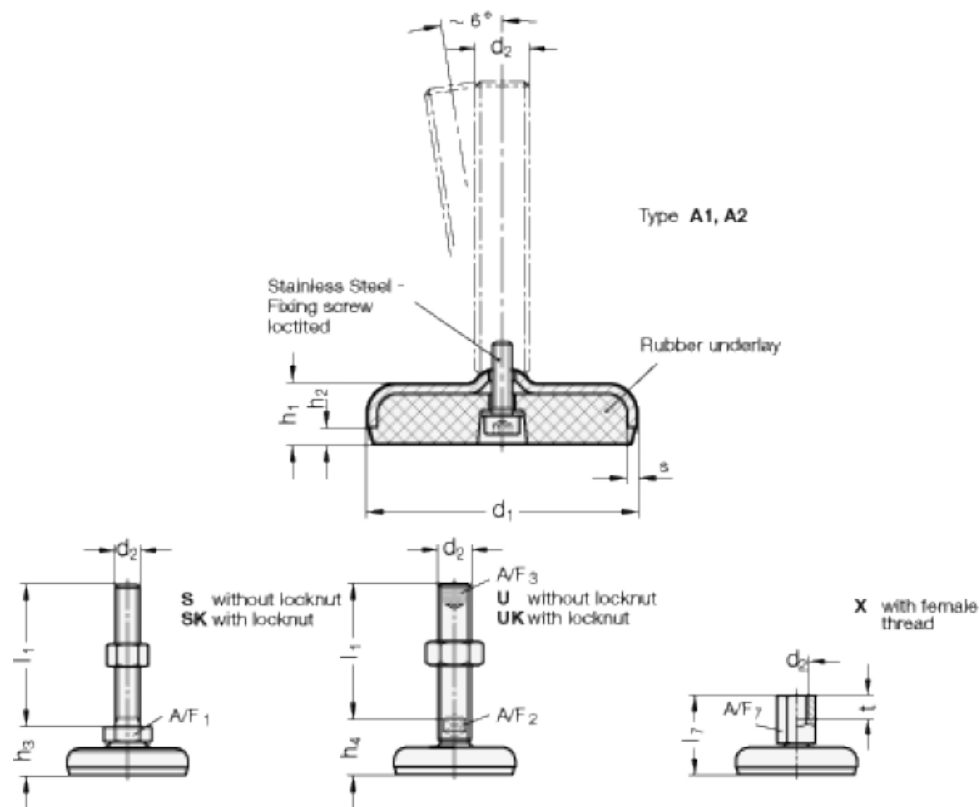

A/F2 = 15
A/F3 = 10
d1 = 120
d2 = M20
h1 = 22
h2 = 6
h4 = 39
l1 = 150

s = 4